

DISANO

125-41486039

MICRO RODIO SYM FLOODLIGHTS made of aluminium, grey, transparent glass beam symmetric, light output direct, tilting 90°, with converter, dimmability: not dimmable, cable black, IP66



SKETCH

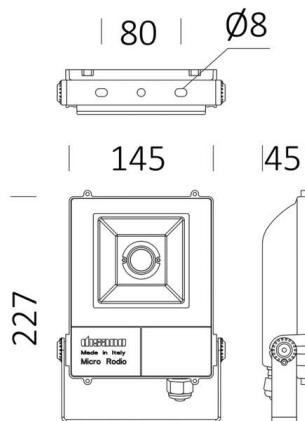

TECHNICAL DETAILS

Light source	LED
System performance [W]	29
Luminous flux [lm]	2702
Colour temperature	3000K
CRI	>90
Optics	transparent glass
Converter	with converter
Dimmability	not dimmable
Light emission area	direct
Beam angle	symmetric
Voltage	220-240V 50/60Hz
Length [mm]	145
Width [mm]	45
Height [mm]	227
IP protection class	IP66
IP protection class	protection cl. I
IK value	IK08
Material	aluminium
Colour of body	grey
Cable	black
Lifetime [h]	50 000
Ambient temperature	from -20° to +40°
Energy efficiency class	D
Net weight [kg]	1.11
EAN number	8012952151886

LIGHT DISTRIBUTION CURVE

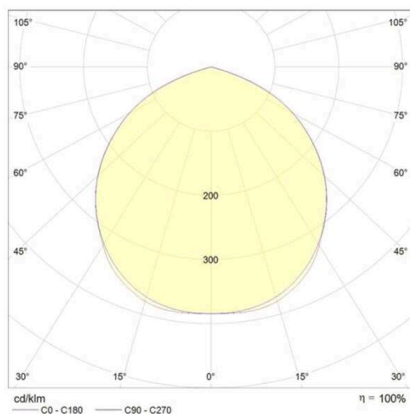

The values are rated values. Power and luminous flux are initially subject to a tolerance of +/- 10%.
Colour temperature tolerance: +/- 150 K. The values apply to an ambient temperature of 25°C unless otherwise specified.