

NOA SYSTEM

208-19106401

3 PHASE TRACK PULSE DALI SD 3 PHASE TRACK made of aluminium, grey, dimmability: DALI, IP20

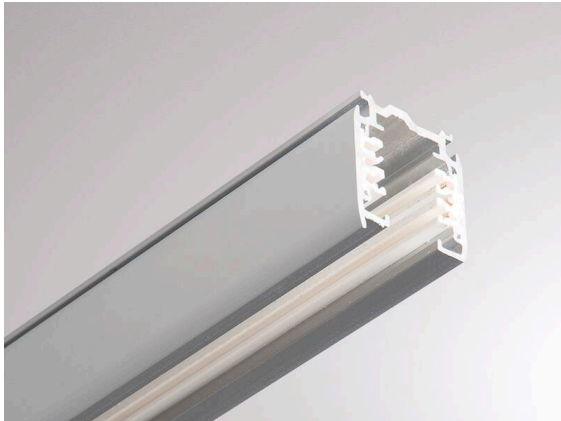

TECHNICAL DETAILS

Dimmability	DALI
Voltage	220-240V 50/60Hz
Length [mm]	4000
Width [mm]	31,5
Mounting depth [mm]	32,5
IP protection class	IP20
IP protection class	protection cl. I
Material	aluminium
Colour of body	grey
Net weight [kg]	3.60
EAN number	9010979801585

SKETCH

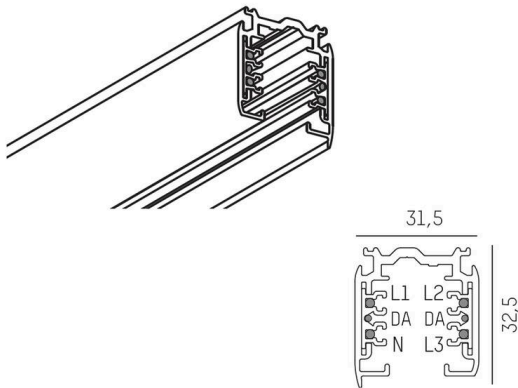

The values are rated values. Power and luminous flux are initially subject to a tolerance of +/- 10%.
Colour temperature tolerance: +/- 150 K. The values apply to an ambient temperature of 25°C unless otherwise specified.