

## NOA SYSTEM

208-19106201

3 PHASE TRACK PULSE DALI SD 3 PHASE TRACK made of aluminium, grey, dimmability: DALI, IP20

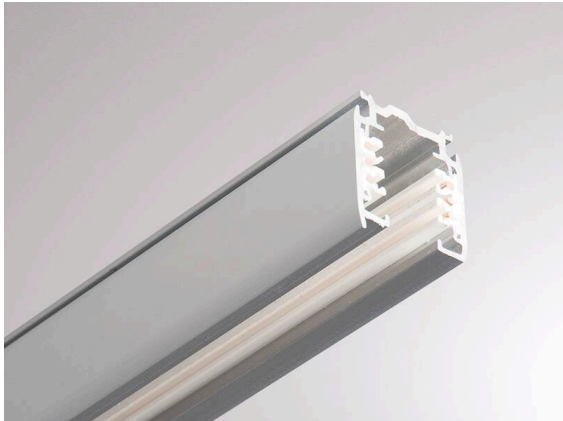

## TECHNICAL DETAILS

Dimmability	DALI
Voltage	220-240V 50/60Hz
Length [mm]	2000
Width [mm]	31,5
Height [mm]	32,5
IP protection class	IP20
IP protection class	protection cl. I
Material	aluminium
Colour of body	grey
Net weight [kg]	1.80
EAN number	6410014531485

## SKETCH

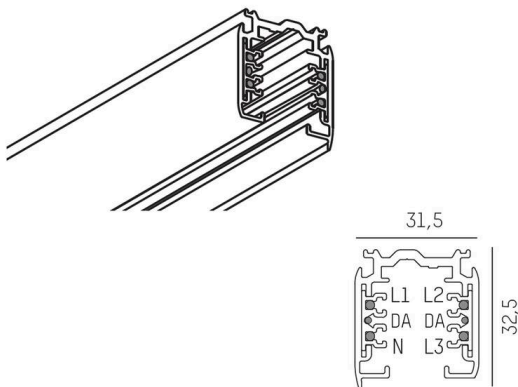

The values are rated values. Power and luminous flux are initially subject to a tolerance of +/- 10%.  
Colour temperature tolerance: +/- 150 K. The values apply to an ambient temperature of 25°C unless otherwise specified.