

NOA SYSTEM

208-19170402

XTS 40-2

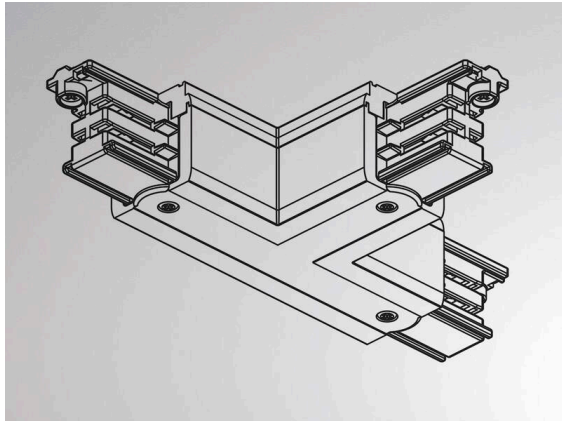

SKETCH

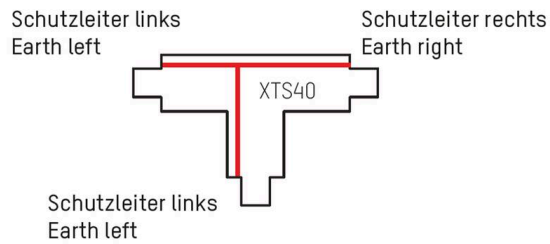

TECHNICAL DETAILS

Dimmability	not dimmable
Voltage	220-240V 50/60Hz
Length [mm]	100
Width [mm]	66
Height [mm]	33
IP protection class	IP20
IP protection class	protection cl. I
Material	synthetic
Colour of body	black
RAL	9005
Net weight [kg]	0.14
EAN number	6410014506407



The values are rated values. Power and luminous flux are initially subject to a tolerance of +/- 10%.
 Colour temperature tolerance: +/- 150 K. The values apply to an ambient temperature of 25°C unless otherwise specified.