

SYSTEM02.1

725-04001301405t

SYSTEM 02.1 F FLOOR LAMP made of die-cast aluminium, white, similar to RAL 9016, light output direct / indirect 30:70, UGR <19, with converter, max. 350mA, dimmability: Push Dim, cable black, IP20 rocker button



SKETCH

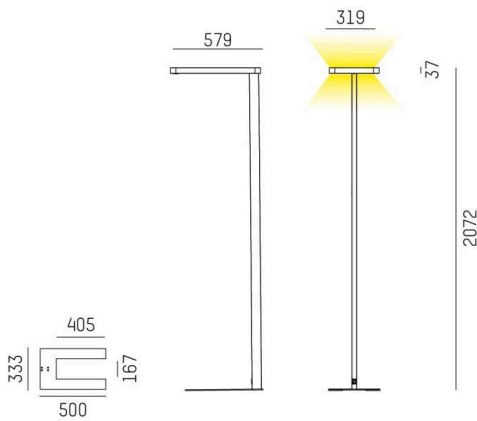

TECHNICAL DETAILS

Light source	LED
System performance [W]	93
Luminous flux [lm]	14290
Current sec. [mA]	350
Colour temperature	4000K
CRI	>80
UGR	<19
Converter	with converter
Dimmability	Push Dim
Light emission area	direct / indirect 30:70
Voltage	220-240V AC/DC
Length [mm]	579
Width [mm]	319
Height [mm]	2072
IP protection class	IP20
IP protection class	protection cl. I
Material	die-cast aluminium
Colour of body	white
RAL	9016
Cable	black
Lifetime [h]	L80 B10 50 000
Energy efficiency class	D
Number of luminaires B16A	18
Net weight [kg]	12.72
EAN number	9010506291858

LIGHT DISTRIBUTION CURVE

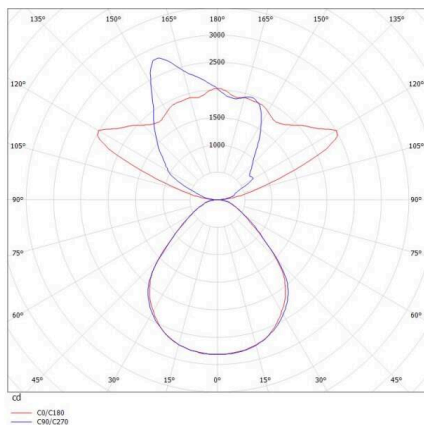

Energy label



The values are rated values. Power and luminous flux are initially subject to a tolerance of +/- 10%.
Colour temperature tolerance: +/- 150 K. The values apply to an ambient temperature of 25°C unless otherwise specified.