

VALO

720-004420147660

VALO SYSTEM DOUBLE SPOT SYSTEM SPOTLIGHT black, similar to RAL 9005,high-efficiently vacuum deposited synthetic reflector beam 24°, light output direct, swiveling 355°, tilting 35°, with converter, max. 350mA, dimmability: not dimmable, adapter/ceiling base white, IP20



SKETCH

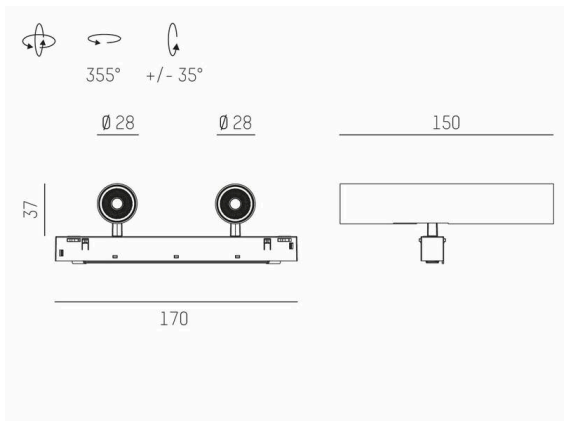

TECHNICAL DETAILS

Light source	LED
System performance [W]	14
Luminous flux [lm]	1440
Current sec. [mA]	350
Colour temperature	3500K
CRI	PREMIUM>90
Optics	vacuum deposited synthetic reflector
Converter	with converter
Dimmability	not dimmable
Light emission area	direct
Beam angle	24°
Voltage	48 VDC
Length [mm]	170
Width [mm]	150
Height [mm]	37
Diameter [mm]	28
IP protection class	IP20
IP protection class	protection cl. II
IK value	IK04
Colour of body	black
RAL	9005
Colour of adapter / ceiling base	white
Lifetime [h]	L80 B10 50 000
Energy efficiency class	D
Net weight [kg]	1.06
EAN number	9010506239591

LIGHT DISTRIBUTION CURVE

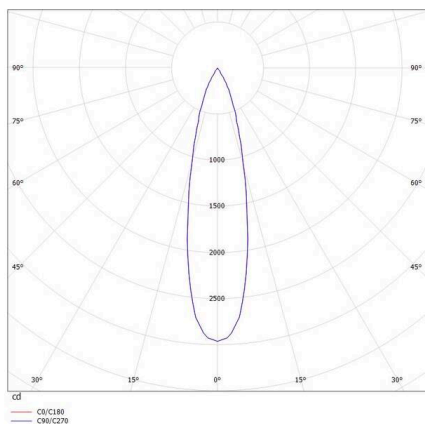

Energy label



The values are rated values. Power and luminous flux are initially subject to a tolerance of +/- 10%.
Colour temperature tolerance: +/- 150 K. The values apply to an ambient temperature of 25°C unless otherwise specified.