

GRID

629-0004114906060

GRID SEMI RECESSED RECESSED SPOTLIGHT made of metal, black, similar to RAL 9005, lens optic with anti-glare grid beam 15°, light output direct, UGR <19, swiveling 355°, tilting 90°, without converter, max. 300/500mA, dimmability: see converter, IP20



TECHNICAL DETAILS

Light source	LED 10W/17W
Luminous flux [lm]	940/1390
Current sec. [mA]	300/500
Colour temperature	3000K
CRI	PREMIUM>90
UGR	<19
Optics	lens optics with glare control louvre
Converter	without converter
Dimmability	see converter
Light emission area	direct
Beam angle	15°
Length [mm]	113
Width [mm]	113
Height [mm]	76
Ceiling cutout [mm]	106x106
Ceiling thickness [mm]	8-30
Mounting depth [mm]	90
IP protection class	IP20
IP protection class	protection cl. II

SKETCH

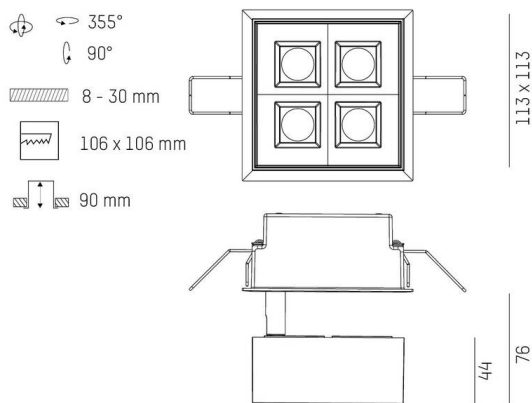

Material	metal
Colour of body	black
RAL	9005
Lifetime [h]	L80 B10 50 000
Energy efficiency class	E
Net weight [kg]	0.78
EAN number	9010979036024



Energy label

LIGHT DISTRIBUTION CURVE

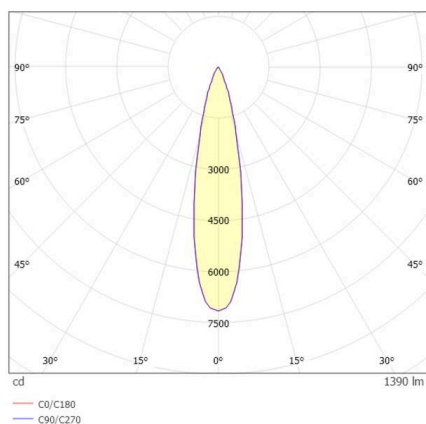

The values are rated values. Power and luminous flux are initially subject to a tolerance of +/- 10%.
Colour temperature tolerance: +/- 150 K. The values apply to an ambient temperature of 25°C unless otherwise specified.