

MAGNETICS

708-002020943060

MAGNETICS SPOT M TRACK SPOTLIGHT WITH 24V ADAPTER made of aluminium, black, similar to RAL 9005, vacuum deposited synthetic Dark-reflector beam 38°, light output direct, swiveling 350°, tilting 90°, without converter, max. 265mA, dimmability: not dimmable, adapter/ceiling base black, IP20



SKETCH

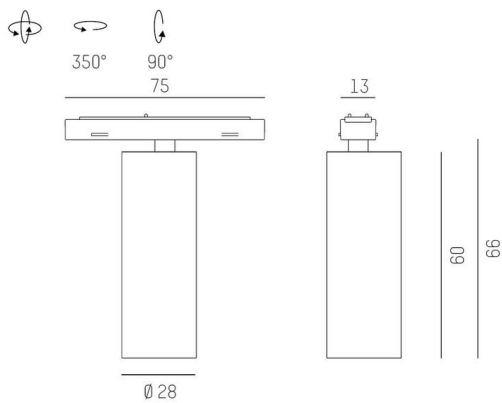

TECHNICAL DETAILS

Light source	LED
System performance [W]	7
Luminous flux [lm]	200
Current sec. [mA]	265
Colour temperature	2700K
CRI	PREMIUM>90
Optics	vacuum deposited synthetic Dark-reflector
Converter	without converter
Dimmability	not dimmable
Light emission area	direct
Beam angle	38°
Voltage	24 VDC
Length [mm]	79,5
Width [mm]	28
Height [mm]	66
Diameter [mm]	28
IP protection class	IP20
IP protection class	protection cl. III
IK value	IK03
Material	aluminium
Colour of body	black
RAL	9005
Colour of adapter / ceiling base	black
Lifetime [h]	L80 B10 50 000
Energy efficiency class	E
Net weight [kg]	0.30
EAN number	9010506292268

LIGHT DISTRIBUTION CURVE

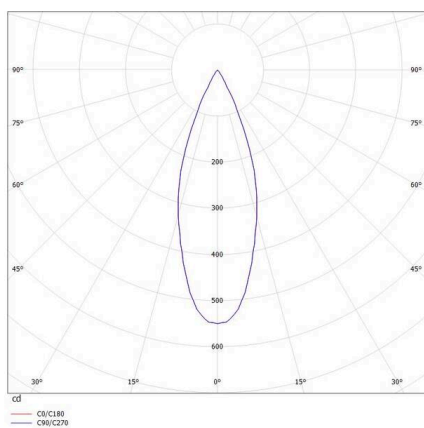

Energy label



The values are rated values. Power and luminous flux are initially subject to a tolerance of +/- 10%.
Colour temperature tolerance: +/- 150 K. The values apply to an ambient temperature of 25°C unless otherwise specified.