

CONCEPT

723-001130314550

CONCEPT DOUBLE F FLOOR LAMP made of aluminium, white, similar to RAL 9016, microfaceted free-form reflector beam for double workplace, light output direct / indirect 30:70, UGR <19, with converter, max. 1500mA, dimmability: not dimmable, cable black, IP20 Membrane switch with USB connection (max.1A)



SKETCH

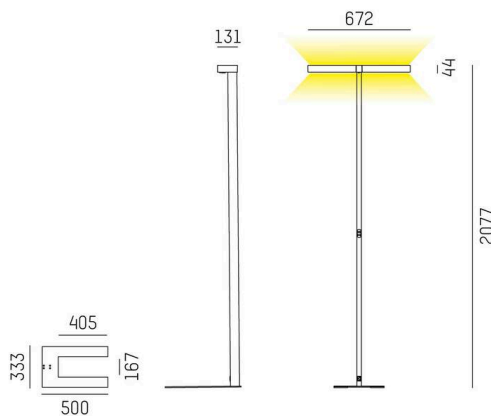

TECHNICAL DETAILS

Light source	LED
System performance [W]	140
Luminous flux [lm]	15420
Current sec. [mA]	1500
Colour temperature	4000K
CRI	>80
UGR	<19
Optics	microfaceted free-form reflector
Converter	with converter
Dimmability	not dimmable
Light emission area	direct / indirect 30:70
Beam angle	for double workplace
Voltage	220-240V AC/DC
Length [mm]	672
Width [mm]	131
Height [mm]	2077
IP protection class	IP20
IP protection class	protection cl. I
Material	aluminium
Colour of body	white
RAL	9016
Cable	black
Lifetime [h]	L80 B10 50 000
Energy efficiency class	D
Number of luminaires B16A	24
Net weight [kg]	14.96
EAN number	9010506301052

LIGHT DISTRIBUTION CURVE

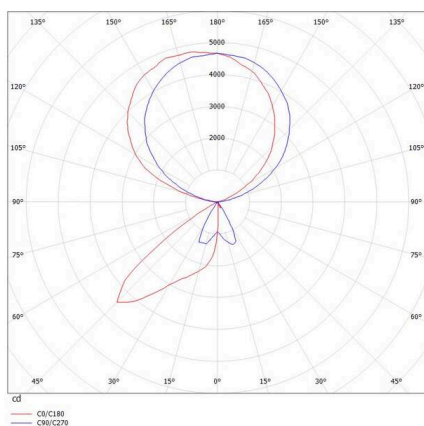

Energy label



The values are rated values. Power and luminous flux are initially subject to a tolerance of +/- 10%.
Colour temperature tolerance: +/- 150 K. The values apply to an ambient temperature of 25°C unless otherwise specified.