

LENS

646-10801032906d

LENS SHORT SINGLE PDI SUSPENSION made of die-cast aluminium, black, similar to RAL 9005, lens optic with anti-glare grid beam for single workplace, light output direct / indirect, UGR <16, with converter, max. 250mA, dimmability: DALI, cable transparent, adapter/ceiling base black matt, pendant length 1500mm, IP20

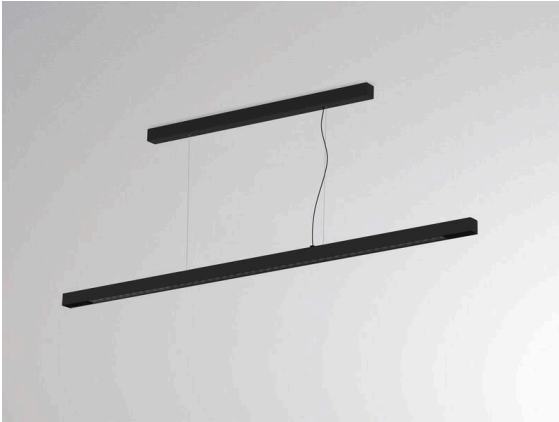

SKETCH

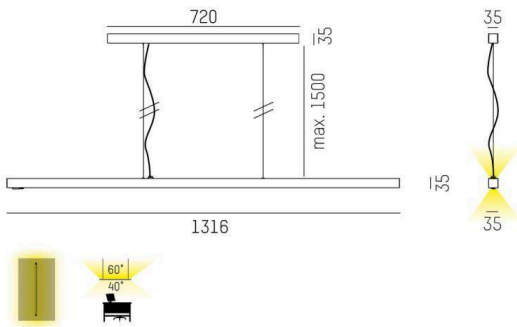

TECHNICAL DETAILS

Light source	LED
System performance [W]	44
Luminous flux [lm]	5854
Current sec. [mA]	250
Colour temperature	3000K
CRI	>80
UGR	<16
Optics	lens optics with glare control louvre
Converter	with converter
Dimmability	DALI
Light emission area	direct / indirect
Beam angle	for single workplace
Voltage	220-240V AC/DC
Length [mm]	1316
Width [mm]	35
Height [mm]	35
Length pendant [mm]	1500
IP protection class	IP20
IP protection class	protection cl. I
IK value	IK05
Material	die-cast aluminium
Colour of body	black
RAL	9005
Colour of adapter / ceiling base	black
Cable	transparent
Lifetime [h]	L80 B10 50 000
Energy efficiency class	E
Number of luminaires B16A	18
Net weight [kg]	4.01
EAN number	9010506807608

LIGHT DISTRIBUTION CURVE

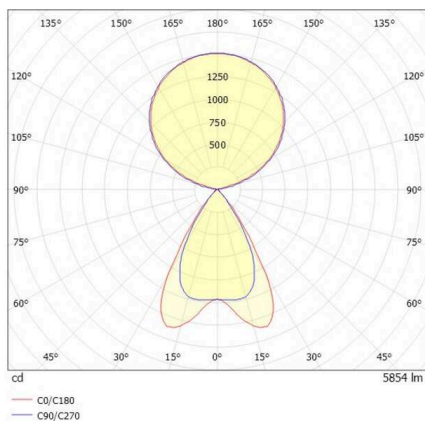

Energy label



The values are rated values. Power and luminous flux are initially subject to a tolerance of +/- 10%.  
Colour temperature tolerance: +/- 150 K. The values apply to an ambient temperature of 25°C unless otherwise specified.