

LOG 50 RING

722-030160111405000

LOG 50 RING 180° PDI SUSPENSION made of aluminium, white, similar to RAL 9016, satined PMMA opal diffuser light output direct / indirect, with converter, max. 350/550mA, dimmability: not dimmable, through wiring 3x1,5mm², pendant length 3000mm, IP20



SKETCH

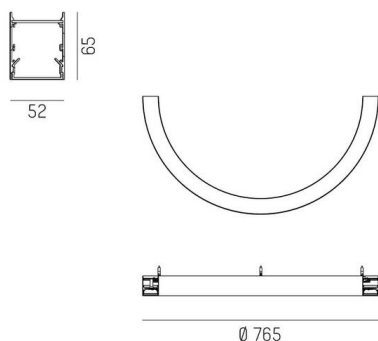

TECHNICAL DETAILS

Light source	LED
System performance [W]	33
Luminous flux [lm]	4310
Current sec. [mA]	350/550
Colour temperature	4000K
CRI	>80
Optics	PMMA opal diffuser
Converter	with converter
Dimmability	not dimmable
Light emission area	direct / indirect
Voltage	220-240V 50/60Hz
Through wiring	3x1,5mm ²
Length [mm]	765
Width [mm]	52
Height [mm]	65
Length pendant [mm]	3000
Diameter [mm]	765
IP protection class	IP20
IP protection class	protection cl. I
IK value	IK03
Material	aluminium
Colour of body	white
RAL	9016
Lifetime [h]	L80 B10 50 000
Energy efficiency class	C
Number of luminaires B16A	25
Net weight [kg]	4.78
EAN number	9010870227095

LIGHT DISTRIBUTION CURVE



Energy label



The values are rated values. Power and luminous flux are initially subject to a tolerance of +/- 10%.
Colour temperature tolerance: +/- 150 K. The values apply to an ambient temperature of 25°C unless otherwise specified.