

MAGNETICS

708-01602002906d

MAGNETICS SPHERE M SD TRACK SPOTLIGHT WITH 24V ADAPTER made of hand-blown glass, black, similar to RAL 9005, satined glass satined, beam 330°, light output direct, UGR <16, without converter, max. 195mA, dimmability: DALI, adapter/ceiling base black, IP20

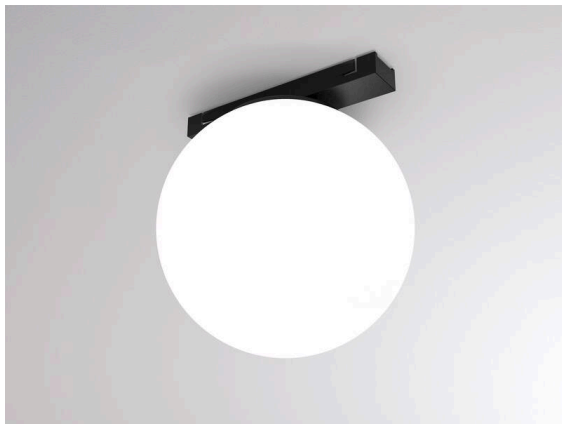

SKETCH

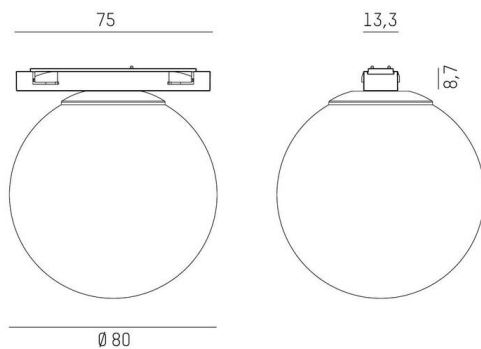

TECHNICAL DETAILS

Light source	LED
System performance [W]	5
Luminous flux [lm]	290
Current sec. [mA]	195
Colour temperature	3000K
CRI	>90
UGR	<16
Optics	satined glass
Converter	without converter
Dimmability	DALI
Light emission area	direct
Beam angle	330°
Voltage	24 VDC
Length [mm]	80
Width [mm]	13,7
Height [mm]	88,60
Diameter [mm]	80
IP protection class	IP20
IP protection class	protection cl. III
IK value	IK00
Material	hand-blown glass
Colour of body	black
RAL	9005
Colour of glass/shade	satined
Colour of adapter / ceiling base	black
Lifetime [h]	L80 B10 50 000
Energy efficiency class	E
Net weight [kg]	0.41
EAN number	9010870398320

LIGHT DISTRIBUTION CURVE

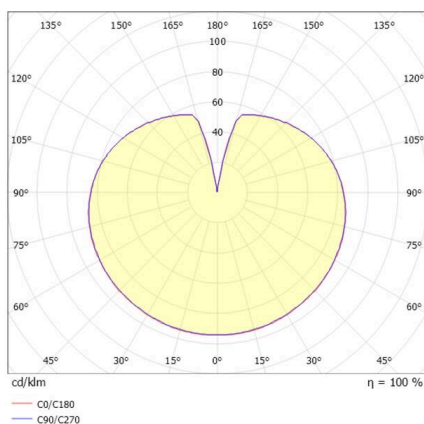

Energy label



The values are rated values. Power and luminous flux are initially subject to a tolerance of +/- 10%.
 Colour temperature tolerance: +/- 150 K. The values apply to an ambient temperature of 25°C unless otherwise specified.