

MAGNETICS

708-10201044706d

MAGNETICS SPOT S TRACK SPOTLIGHT WITH 24V ADAPTER made of aluminium, black, similar to RAL 9005, High-Precision-Anti-Glare-Lens beam 20°, light output direct, swiveling 350°, tilting 90°, without converter, max. 195mA, dimmability: DALI, adapter/ceiling base black, IP20



TECHNICAL DETAILS

Light source	LED
System performance [W]	4
Luminous flux [lm]	330
Current sec. [mA]	195
Colour temperature	3500K
CRI	PREMIUM>90
Optics	high-Precision-Anti-Glare-Lens
Converter	without converter
Dimmability	DALI
Light emission area	direct
Beam angle	20°
Voltage	24 VDC

Length [mm]	75
Width [mm]	22
Height [mm]	52
Diameter [mm]	22
IP protection class	IP20
IP protection class	protection cl. III
IK value	IK03

Material	aluminium
Colour of body	black
RAL	9005
Colour of adapter / ceiling base	black
Lifetime [h]	L80 B10 50 000
Energy efficiency class	E

Net weight [kg]	0.64
EAN number	9010506957549



Energy label

SKETCH

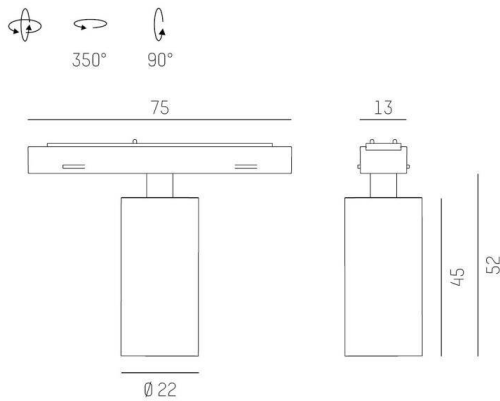

LIGHT DISTRIBUTION CURVE

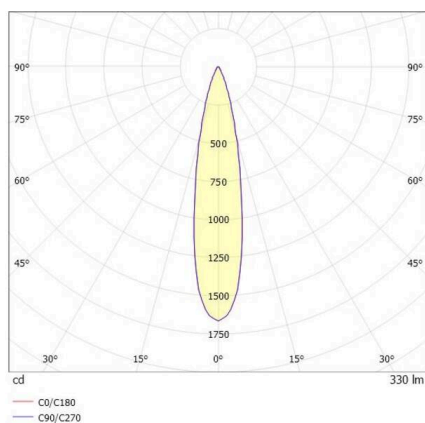

The values are rated values. Power and luminous flux are initially subject to a tolerance of +/- 10%.
 Colour temperature tolerance: +/- 150 K. The values apply to an ambient temperature of 25°C unless otherwise specified.