

CONCEPT

723-10113031966m

CONCEPT DOUBLE F FLOOR LAMP made of aluminium, black, similar to RAL 9005, microfaceted free-form reflector beam for double workplace, light output direct / indirect 30:70, UGR <19, with converter, max. 1500mA, dimmability: motion swarm, with motion detector, day light control and swarm function, cable black, IP20 out of the box mode - with activated daylight control and motion detection



SKETCH

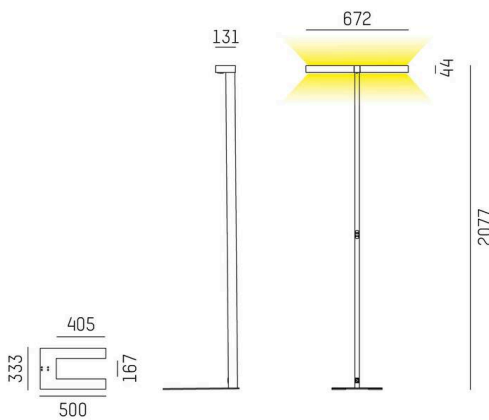

TECHNICAL DETAILS

Light source	LED
System performance [W]	140
Luminous flux [lm]	14800
Current sec. [mA]	1500
Colour temperature	3000K
CRI	>80
UGR	<19
Optics	microfaceted free-form reflector
Converter	with converter
Dimmability	motion swarm
Light emission area	direct / indirect 30:70
Beam angle	for double workplace
Voltage	220-240V AC/DC
Motion detector	with motion detector, day light control and swarm function
Length [mm]	672
Width [mm]	131
Height [mm]	2077
IP protection class	IP20
IP protection class	protection cl. I
Material	aluminium
Colour of body	black
RAL	9005
Cable	black
Lifetime [h]	L80 B10 50 000
Energy efficiency class	D
Number of luminaires B16A	18
Net weight [kg]	14.57
EAN number	9010506849462

LIGHT DISTRIBUTION CURVE

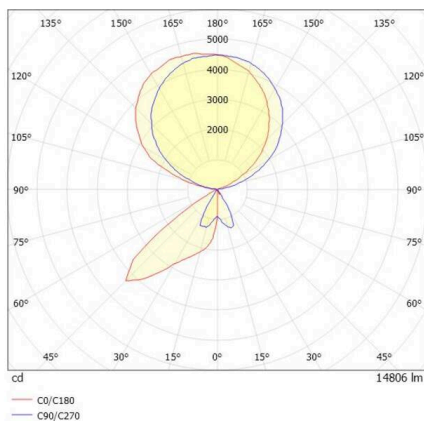

Energy label



The values are rated values. Power and luminous flux are initially subject to a tolerance of +/- 10%.
Colour temperature tolerance: +/- 150 K. The values apply to an ambient temperature of 25°C unless otherwise specified.