

LENS

646-20502052905m

LENS QUAD PDI SUSPENSION made of die-cast aluminium, white, similar to RAL 9016, lens optic with anti-glare grid beam for quadruple workplace, light output direct / indirect, UGR <16, with converter, max. 525mA, dimmability: motion swarm, with motion detector, day light control and swarm function, cable transparent, adapter/ceiling base white matt, pendant length 1500mm, IP20 out of the box mode - with activated daylight control and motion detection



SKETCH

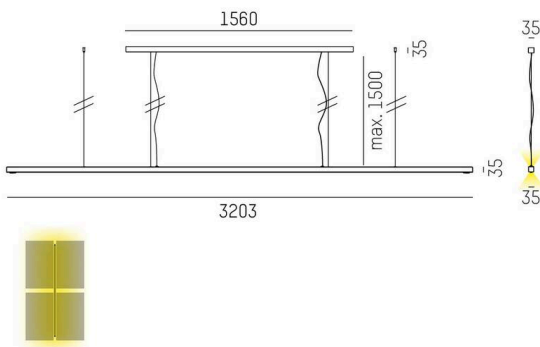

TECHNICAL DETAILS

Light source	LED
System performance [W]	200
Luminous flux [lm]	23380
Current sec. [mA]	525
Colour temperature	3000K
CRI	>80
UGR	<16
Optics	lens optics with glare control louvre
Converter	with converter
Dimmability	motion swarm
Light emission area	direct / indirect
Beam angle	for quadruple workplace
Voltage	220-240V AC/DC
Motion detector	with motion detector, day light control and swarm function
Length [mm]	3203
Width [mm]	35
Height [mm]	35
Length pendant [mm]	1500
IP protection class	IP20
IP protection class	protection cl. I
IK value	IK05
Material	die-cast aluminium
Colour of body	white
RAL	9016
Colour of adapter / ceiling base	white
Cable	transparent
Lifetime [h]	L80 B10 50 000
Energy efficiency class	E
Number of luminaires B16A	18
Net weight [kg]	8.38
EAN number	9010506848052

LIGHT DISTRIBUTION CURVE

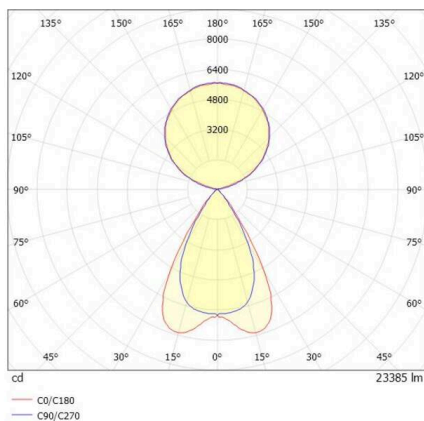

Energy label



The values are rated values. Power and luminous flux are initially subject to a tolerance of +/- 10%. Colour temperature tolerance: +/- 150 K. The values apply to an ambient temperature of 25°C unless otherwise specified.