

LOG 50 RING

722-0201a0111305000

LOG 50 RING 90° PD SUSPENSION made of aluminium, white, similar to RAL 9016, satined PMMA opal diffuser light output direct, with converter, max. 350mA, dimmability: not dimmable, through wiring 3x1,5mm², pendant length 3000mm, IP20

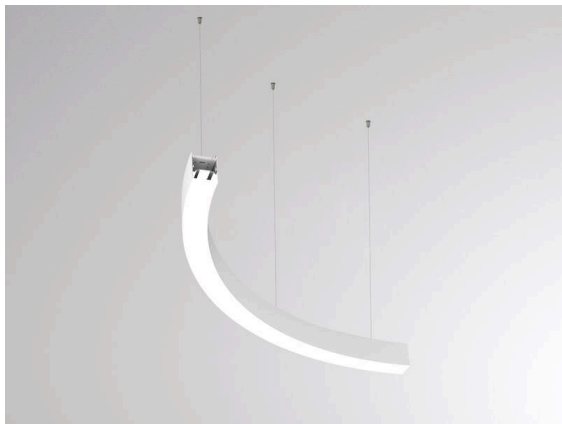

SKETCH

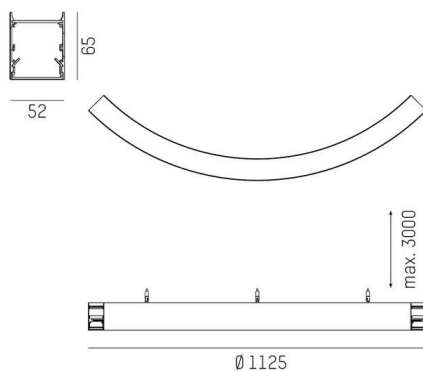

TECHNICAL DETAILS

Light source	LED
System performance [W]	7
Luminous flux [lm]	840
Current sec. [mA]	350
Colour temperature	2700K
CRI	>80
Optics	PMMA opal diffuser
Converter	with converter
Dimmability	not dimmable
Light emission area	direct
Voltage	220-240V 50/60Hz
Through wiring	3x1,5mm²
Length [mm]	382,5
Width [mm]	52
Height [mm]	65
Length pendant [mm]	3000
Diameter [mm]	765
IP protection class	IP20
IP protection class	protection cl. I
IK value	IK03
Material	aluminium
Colour of body	white
RAL	9016
Lifetime [h]	L80 B10 50 000
Energy efficiency class	C
Number of luminaires B16A	50
Net weight [kg]	2.52
EAN number	9010870194472

LIGHT DISTRIBUTION CURVE

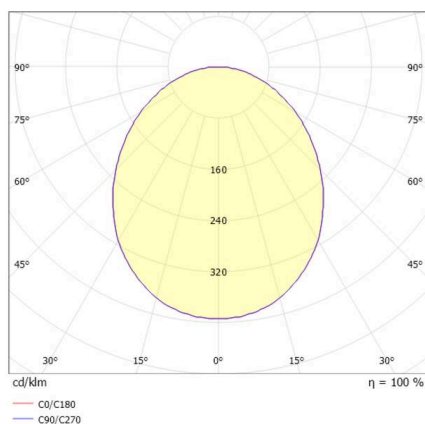

Energy label



The values are rated values. Power and luminous flux are initially subject to a tolerance of +/- 10%.
 Colour temperature tolerance: +/- 150 K. The values apply to an ambient temperature of 25°C unless otherwise specified.