

DARK NIGHT

684-00404054905v1

DARK NIGHT TURN XS R RECESSED SPOTLIGHT made of aluminium, white, similar to RAL 9016, decor gold,high-efficiently vacuum deposited aluminium reflector beam 40°, light output direct, UGR <19, swiveling 355°, tilting 25°, without converter, max. 250/350mA, dimmability: see converter, IP20



SKETCH

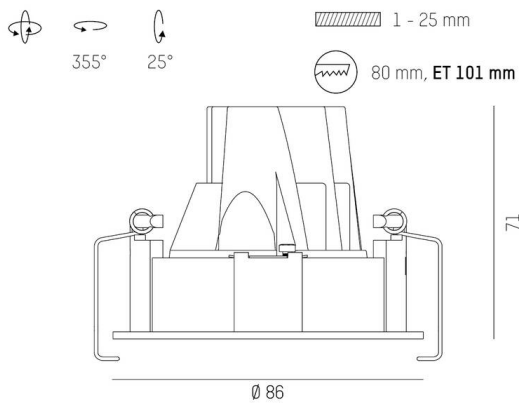

TECHNICAL DETAILS

Light source	LED 9/13W
Luminous flux [lm]	870/1170
Current sec. [mA]	250/350
Colour temperature	3000K
CRI	PREMIUM>90
UGR	<19
Optics	vacuum deposited aluminium reflector
Converter	without converter
Dimmability	see converter
Light emission area	direct
Beam angle	40°
Length [mm]	86
Height [mm]	71
Diameter [mm]	86
Ceiling cutout [mm]	80
Ceiling thickness [mm]	1-25
Mounting depth [mm]	101
IP protection class	IP20
IP protection class	protection cl. II
IK value	IK02
Material	aluminium
Colour of body	white
RAL	9016
Colour of decor	gold
Lifetime [h]	L80 B10 50 000
Energy efficiency class	E
Net weight [kg]	0.34
EAN number	9010506116458

LIGHT DISTRIBUTION CURVE

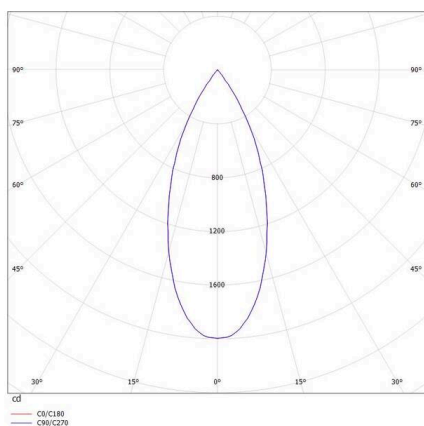

Energy label



The values are rated values. Power and luminous flux are initially subject to a tolerance of +/- 10%.
Colour temperature tolerance: +/- 150 K. The values apply to an ambient temperature of 25°C unless otherwise specified.