

ARTIS

704-21211028405v1

ARTIS 2 SINGLE SHELF R RECESSED SPOTLIGHT made of aluminium, white, similar to RAL 9016, high-efficiently vacuum deposited synthetic reflector beam reflector for gondola head, light output direct, tilting 30°, without converter, max. 800mA, dimmability: see converter, IP20



SKETCH

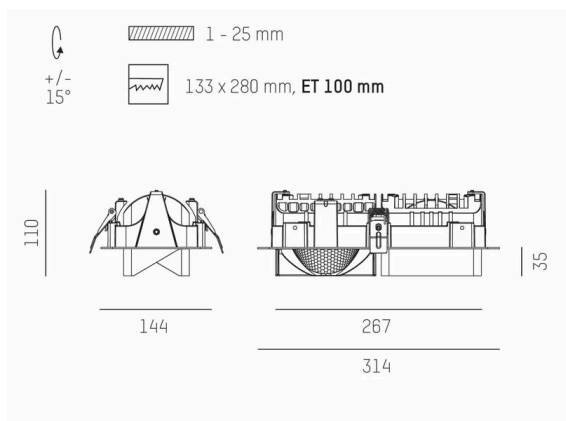

TECHNICAL DETAILS

Light source	LED 80W
Luminous flux [lm]	7790
Current sec. [mA]	800
Colour temperature	4000K
CRI	HE>90
Optics	vacuum deposited synthetic reflector
Converter	without converter
Dimmability	see converter
Light emission area	direct
Beam angle	reflector for gondola head
Length [mm]	314
Width [mm]	144
Height [mm]	110/35
Ceiling cutout [mm]	133x280
Ceiling thickness [mm]	1-25
Mounting depth [mm]	100
IP protection class	IP20
IP protection class	protection cl. II
Material	aluminium
Colour of body	white
RAL	9016
Lifetime [h]	L80 B10 50 000
Energy efficiency class	D
Net weight [kg]	1.61
EAN number	9010870317253

LIGHT DISTRIBUTION CURVE

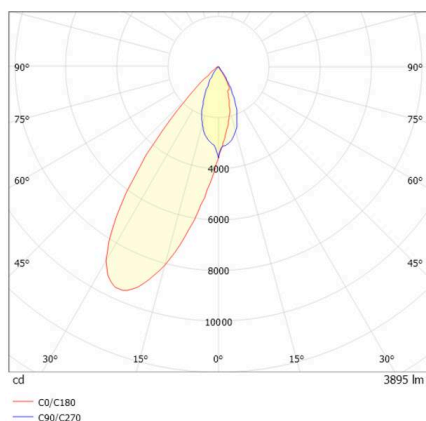

Energy label



The values are rated values. Power and luminous flux are initially subject to a tolerance of +/- 10%. Colour temperature tolerance: +/- 150 K. The values apply to an ambient temperature of 25°C unless otherwise specified.