

ARTIS

704-11201024705pv1

ARTIS 2 TRACK TRACK SPOTLIGHT WITH 3 PH ADAPTER made of aluminium, white, similar to RAL 9016,high-efficiently vacuum deposited synthetic reflector beam double asymmetric, light output direct, swiveling 350°, tilting 30°, with converter, max. 1050mA, dimmability: Pulse-DALI, adapter/ceiling base white, IP20 with the option of attaching the Lightguider for lighting the 3rd level

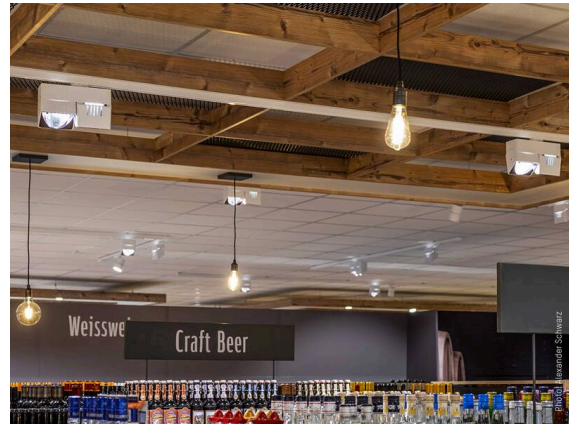

SKETCH

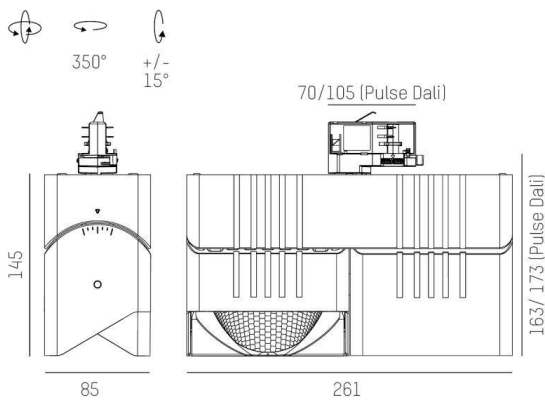

TECHNICAL DETAILS

Light source	LED
System performance [W]	80
Luminous flux [lm]	9040
Current sec. [mA]	1050
Colour temperature	3500K
CRI	PREMIUM>90
Optics	vacuum deposited synthetic reflector
Converter	with converter
Dimmability	Pulse-DALI
Light emission area	direct
Beam angle	double asymmetric
Voltage	220-240V 50/60Hz
Length [mm]	261
Width [mm]	85
Height [mm]	173
IP protection class	IP20
IP protection class	protection cl. I
Material	aluminium
Colour of body	white
RAL	9016
Colour of adapter / ceiling base	white
Lifetime [h]	L80 B10 50 000
Energy efficiency class	E
Number of luminaires B16A	25
Net weight [kg]	2.36
EAN number	9010870354180

LIGHT DISTRIBUTION CURVE

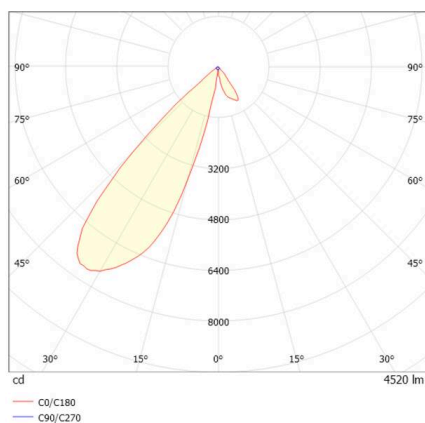

Energy label



The values are rated values. Power and luminous flux are initially subject to a tolerance of +/- 10%.
Colour temperature tolerance: +/- 150 K. The values apply to an ambient temperature of 25°C unless otherwise specified.