

LON

224-012112129050500d

LON ROUND 1000 PDI SUSPENSION made of aluminium, white, similar to RAL 9016, opal silicone diffuser beam 114°, light output direct / indirect, with converter, dimmability: DALI, cable black, soft-touch, adapter/ceiling base white, pendant length 3000mm, IP20 central ceiling base



SKETCH

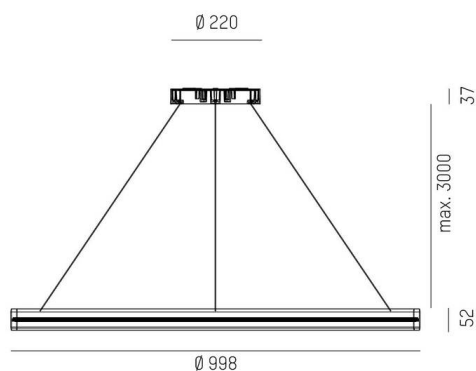

TECHNICAL DETAILS

Light source	LED
System performance [W]	68
Luminous flux [lm]	3960
Colour temperature	3000K
CRI	>90
Optics	opal silicone diffuser
Converter	with converter
Dimmability	DALI
Light emission area	direct / indirect
Beam angle	114°
Voltage	220-240V 50/60Hz
Length [mm]	998
Length pendant [mm]	3000
Diameter [mm]	1000
IP protection class	IP20
IP protection class	protection cl. I
Material	aluminium
Colour of body	white
RAL	9016
Colour of adapter / ceiling base	white
Cable	black, soft-touch
Lifetime [h]	L80 B10 50 000
Energy efficiency class	G
Net weight [kg]	4.53
EAN number	9010979041202

LIGHT DISTRIBUTION CURVE



Energy label



The values are rated values. Power and luminous flux are initially subject to a tolerance of +/- 10%.
Colour temperature tolerance: +/- 150 K. The values apply to an ambient temperature of 25°C unless otherwise specified.