

ARTIS

704-21201024706v1

ARTIS 2 R RECESSED SPOTLIGHT made of aluminium, black, similar to RAL 9005, high-efficiently vacuum deposited synthetic reflector beam double asymmetric, light output direct, tilting 30°, without converter, max. 1050mA, dimmability: see converter, IP20 with the option of attaching the Lightguider for lighting the 3rd level



SKETCH

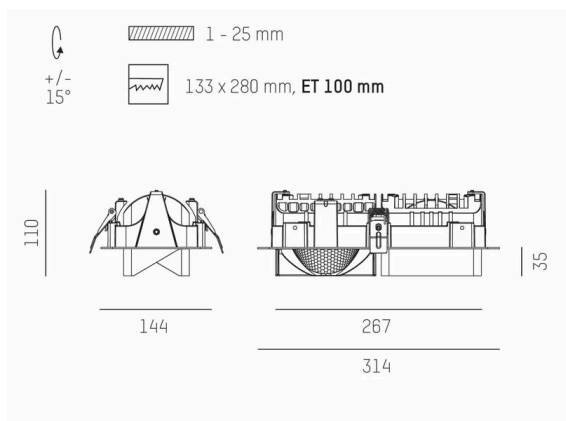

TECHNICAL DETAILS

Light source	LED 80W
Luminous flux [lm]	9040
Current sec. [mA]	1050
Colour temperature	3500K
CRI	PREMIUM >90
Optics	vacuum deposited synthetic reflector
Converter	without converter
Dimmability	see converter
Light emission area	direct
Beam angle	double asymmetric
Length [mm]	313,8
Width [mm]	144
Height [mm]	110/35
Ceiling cutout [mm]	133x280
Ceiling thickness [mm]	1-25
Mounting depth [mm]	100
IP protection class	IP20
IP protection class	protection cl. II
Material	aluminium
Colour of body	black
RAL	9005
Lifetime [h]	L80 B10 50 000
Energy efficiency class	E
Net weight [kg]	1.41
EAN number	9010870354500

LIGHT DISTRIBUTION CURVE

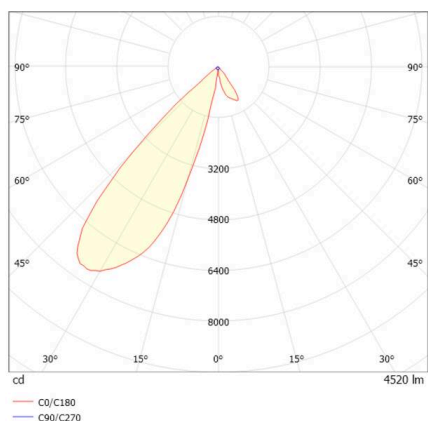

Energy label



The values are rated values. Power and luminous flux are initially subject to a tolerance of +/- 10%.
Colour temperature tolerance: +/- 150 K. The values apply to an ambient temperature of 25°C unless otherwise specified.