

AGON

222-00140

AGON SQUARE RECESSED SPOTLIGHT white, similar to RAL 9003, lens beam 36°, light output direct, UGR <22, tilting 30°, without converter, max. 250/500mA, dimmability: see converter, IP20

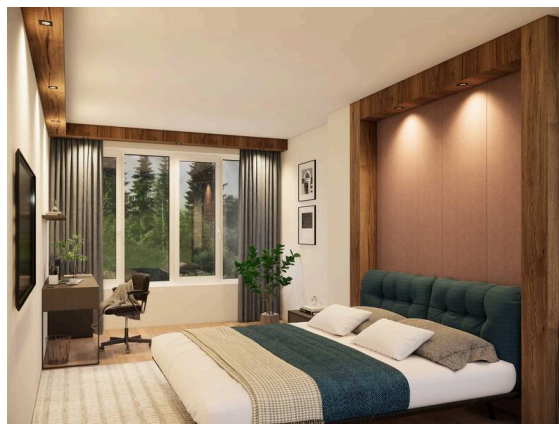

SKETCH

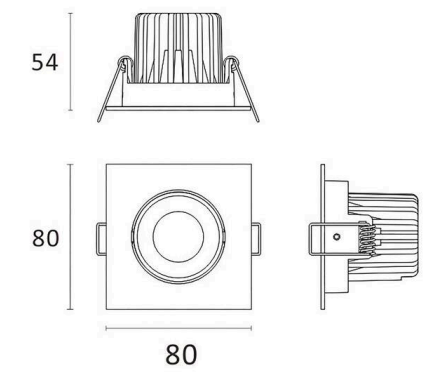

TECHNICAL DETAILS

Light source	LED 9W
Luminous flux [lm]	415/705
Current sec. [mA]	250/500
Colour temperature	2700K
CRI	>90
UGR	<22
Optics	lens
Converter	without converter
Dimmability	see converter
Light emission area	direct
Beam angle	36°
Voltage	18 VDC
Length [mm]	80
Width [mm]	80
Height [mm]	54
Ceiling cutout [mm]	68
Ceiling thickness [mm]	20
Mounting depth [mm]	84
IP protection class	IP20
IP protection class	protection cl. III
Colour of body	white
RAL	9003
Lifetime [h]	L80 B10 50 000
Energy efficiency class	F
Net weight [kg]	0.22
EAN number	9010870539983

LIGHT DISTRIBUTION CURVE

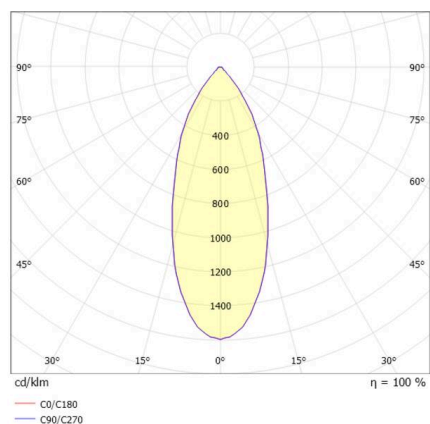

Energy label



The values are rated values. Power and luminous flux are initially subject to a tolerance of +/- 10%. Colour temperature tolerance: +/- 150 K. The values apply to an ambient temperature of 25°C unless otherwise specified.