

SUNRAY

222-00208

SUNRAY I R RECESSED DOWNLIGHT made of aluminium, white, similar to RAL 9003, high-efficiently vacuum deposited aluminium reflector beam 36°, light output direct, UGR <19, without converter, max. 250/350mA, dimmability: see converter, IP40/IP20

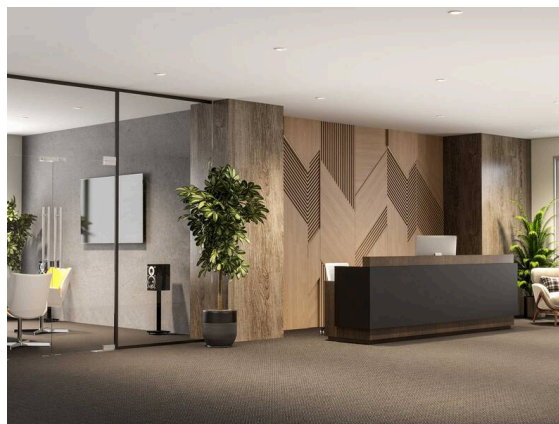

SKETCH

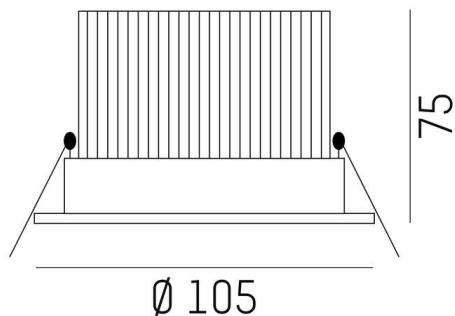

TECHNICAL DETAILS

Light source	LED 13W
Luminous flux [lm]	1000/1400
Current sec. [mA]	250/350
Colour temperature	3000K
CRI	>80
UGR	<19
Optics	vacuum deposited aluminium reflector
Converter	without converter
Dimmability	see converter
Light emission area	direct
Beam angle	36°
Voltage	37 VDC
Height [mm]	75
Diameter [mm]	105
Ceiling cutout [mm]	95
Ceiling thickness [mm]	max. 20mm
Mounting depth [mm]	105
IP protection class	IP40/IP20
IP protection class	protection cl. III
Material	aluminium
Colour of body	white
RAL	9003
Lifetime [h]	L80 B10 70 000
Energy efficiency class	E
Net weight [kg]	0.30
EAN number	9010870891340

LIGHT DISTRIBUTION CURVE

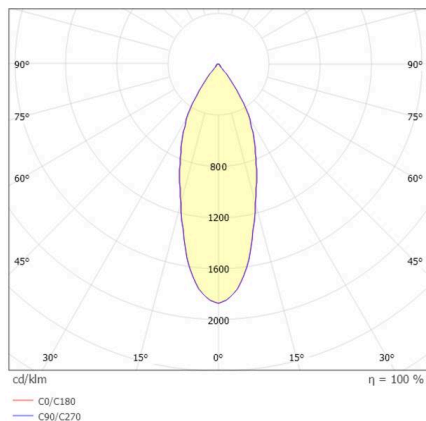

Energy label



The values are rated values. Power and luminous flux are initially subject to a tolerance of +/- 10%.
Colour temperature tolerance: +/- 150 K. The values apply to an ambient temperature of 25°C unless otherwise specified.