

LOG IN/LOG OUT 2.1

728-602043214060

LOG 2.1 SYSTEM EINSATZ BINA OFFICE LIGHT INSERT made of aluminium, black, similar to RAL 9005, microprismatic PMMA cover for perfect anti-glare light output direct, UGR <19, with converter, max. 950mA, dimmability: not dimmable, through wiring 3x1,5mm², IP20

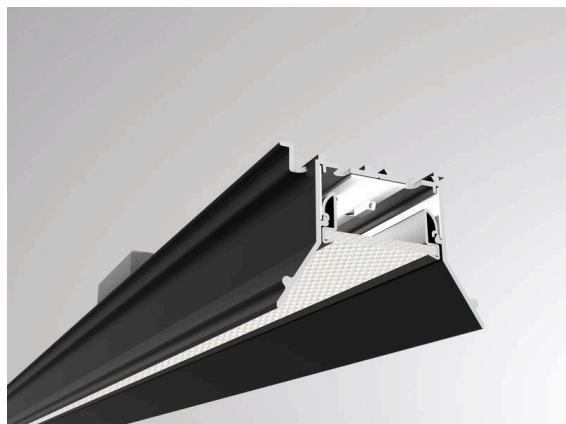

TECHNICAL DETAILS

Light source	LED
System performance [W]	34
Luminous flux [lm]	2960
Current sec. [mA]	950
Colour temperature	4000K
CRI	>80
UGR	<19
Optics	microprismatic cover
Converter	with converter
Dimmability	not dimmable
Light emission area	direct
Voltage	220-240V 50/60Hz
Through wiring	3x1,5mm²
Length [mm]	1124
IP protection class	IP20
IP protection class	protection cl. I
IK value	IK06
Material	aluminium
Colour of body	black
RAL	9005
Lifetime [h]	L80 B10 50 000
Energy efficiency class	D
Number of luminaires B16A	50
Net weight [kg]	2.11
EAN number	9010506089455

SKETCH

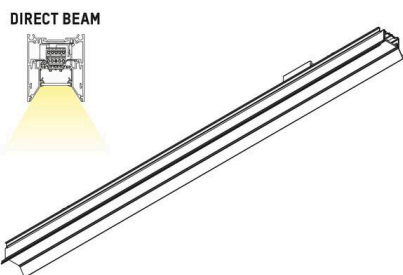

Energy label



The values are rated values. Power and luminous flux are initially subject to a tolerance of +/- 10%.
 Colour temperature tolerance: +/- 150 K. The values apply to an ambient temperature of 25°C unless otherwise specified.