

## LOG IN/LOG OUT 2.1

728-60203321406d

LOG 2.1 SYSTEM EINSATZ BINA OFFICE LIGHT INSERT made of aluminium, black, similar to RAL 9005, microprismatic PMMA cover for perfect anti-glare light output direct, UGR <19, with converter, max. 950mA, dimmability: DALI, through wiring 3x1,5mm<sup>2</sup> + 2x0,75mm<sup>2</sup>, IP20

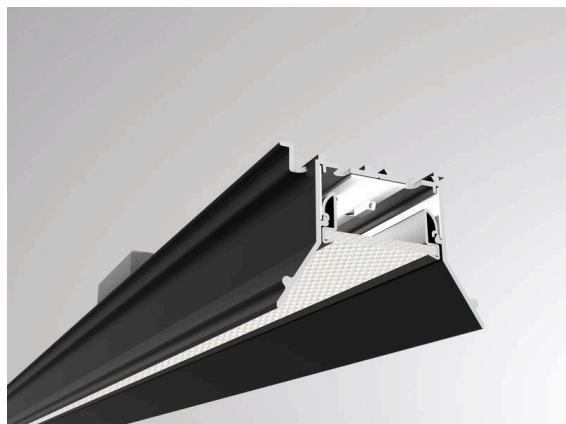

## SKETCH

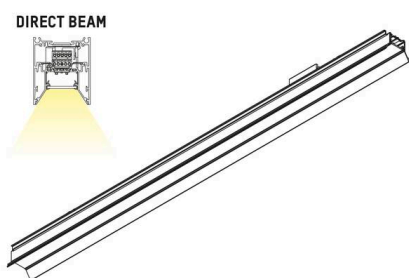

## TECHNICAL DETAILS

|                           |  |
|---------------------------|--|
| Light source              | LED  |
| System performance [W]    | 26   |
| Luminous flux [lm]        | 2220   |
| Current sec. [mA]         | 950  |
| Colour temperature        | 4000K  |
| CRI                       | >80  |
| UGR                       | <19  |
| Optics                    | microprismatic cover                         |
| Converter                 | with converter                               |
| Dimmability               | DALI   |
| Light emission area       | direct                                       |
| Voltage                   | 220-240V 50/60Hz                             |
| Through wiring            | 3x1,5mm <sup>2</sup> + 2x0,75mm <sup>2</sup> |
| Length [mm]               | 844  |
| IP protection class       | IP20   |
| IP protection class       | protection cl. I                             |
| IK value                  | IK06   |
| Material                  | aluminium                                    |
| Colour of body            | black  |
| RAL                       | 9005   |
| Lifetime [h]              | L80 B10 50 000                               |
| Energy efficiency class   | D  |
| Number of luminaires B16A | 50   |
| Net weight [kg]           | 1.74   |
| EAN number                | 9010506089288                                |



Energy label



The values are rated values. Power and luminous flux are initially subject to a tolerance of +/- 10%.  
Colour temperature tolerance: +/- 150 K. The values apply to an ambient temperature of 25°C unless otherwise specified.